

Thule ThruRide 565

› Instructions



CITY CRASH
Complies with ISO norm



THULE WingBar

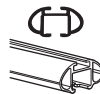

THULE AeroBar



THULE SlideBar



THULE ProBar

565001

C.20151019
501-8124-01

Bring your life
thule.com

EN Roof-mounted bike carrier
DE Dachfahrradträger
FR Porte-vélo sur le toit
NL Fietsdrager voor op het dak
IT Portabici da installare sul tetto
ES Portabicicletas de techo
PT Suporte para bicicleta para teto
SV Takmonterad cykelhållare
DK Tagmonteret cykelholder
NO Takmonterte lasteholdere
FI Katolle asennettava polkupyöräteline
ET Katusele paigaldatav jalgrattahoidik
LV Uz jumta uzstādāms velosipēdu turētājs
LT Ant stogo tvirtinami dviračių laikikliai
PL Bagażnik rowerowy montowany na dachu
RU Устанавливаемое на крыше крепление для велосипедов

UK Багажник для велосипедів, що монтується на даху
BG Покривен багажник за велосипеди
CS Nosič jízdních kol s montáží na střechu
SK Nosič bicyklov s montážou na strechu
SL Nosilec za kolesa
HR/BiH Krovni nosač bicikla
RO Suport pentru bicicletă montat pe pavilion
HU Tetőre szerelhető kerékpártartó
EL Σχάρα ποδηλάτου οροφής
TR Araç üstüne bağlanan bisiklet taşıyıcı
HE משא אופני על הגג
AR حامل الدراجة للتثبيت على السقف
ZH 頂置自行車架
JA ルーフマウント型サイクルキャリア
KO 지붕 장착 자전거 캐리어
TH โครงยึดจักรยานแบบติดตั้งบนหลังคา

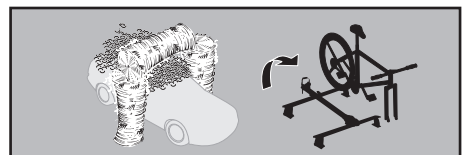
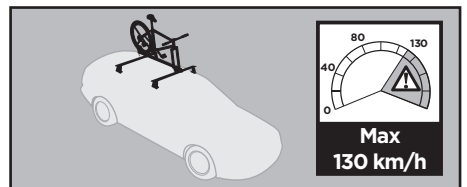
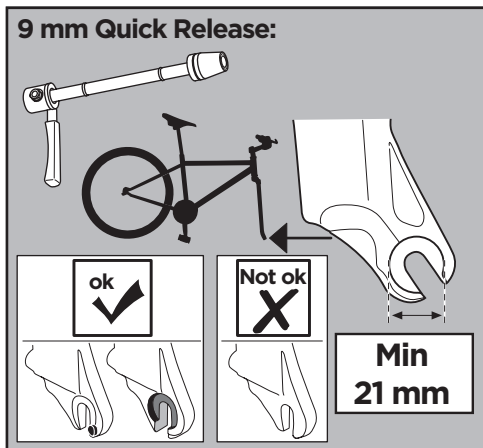
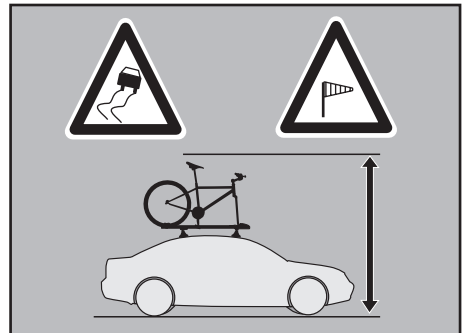
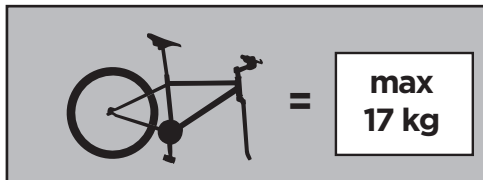
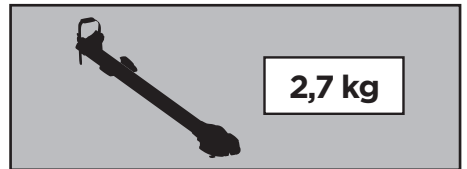
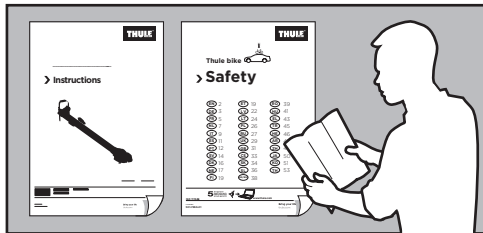

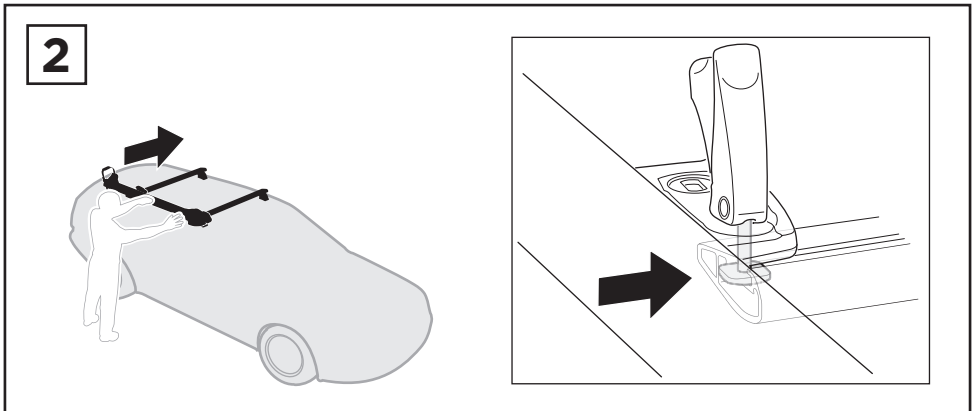
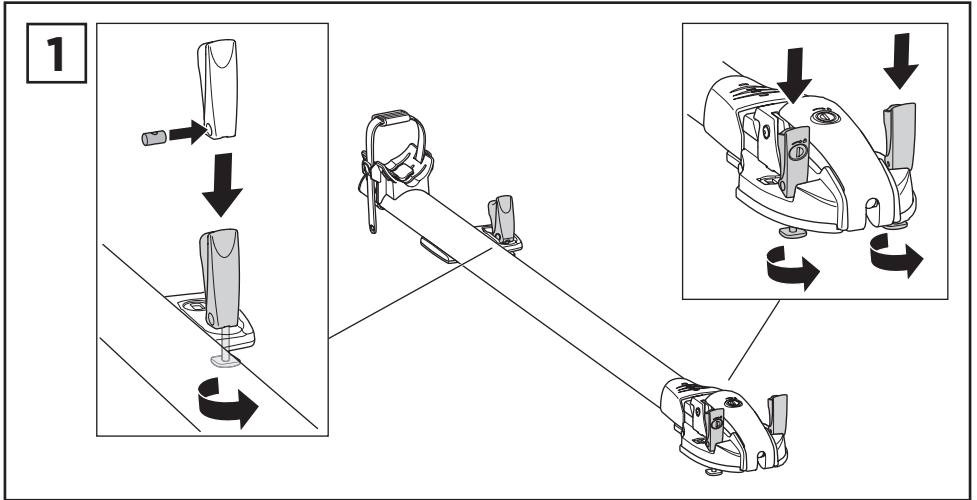
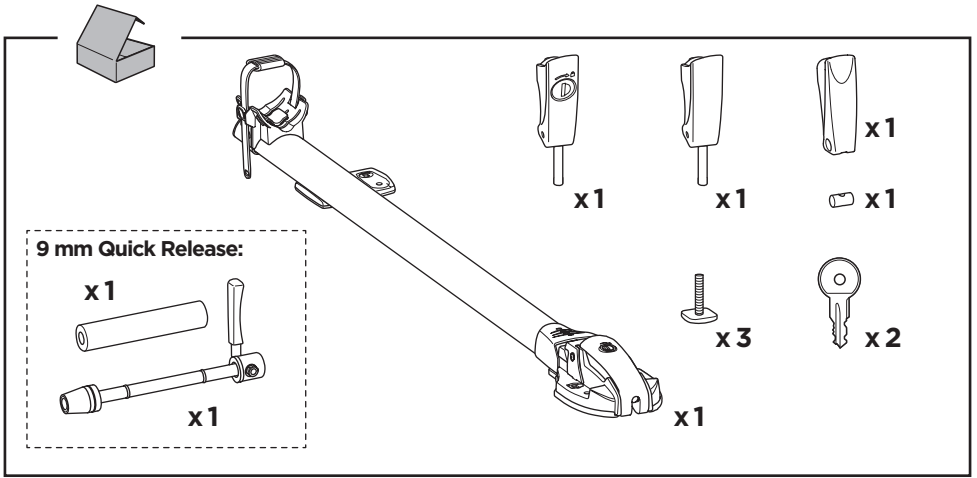

3

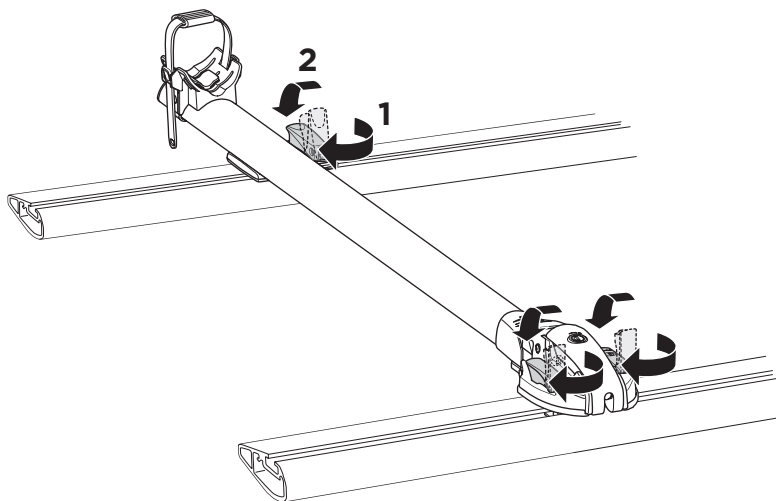

4

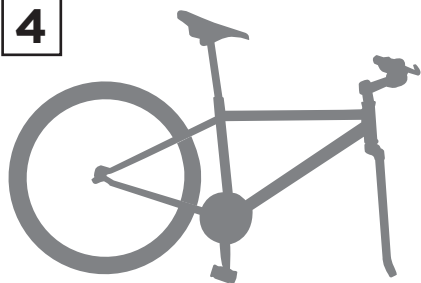

12-20 mm Thru Axles:

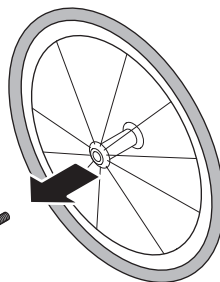

9 mm Quick Release:

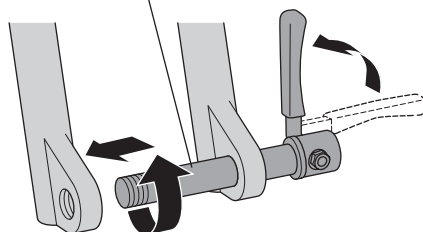
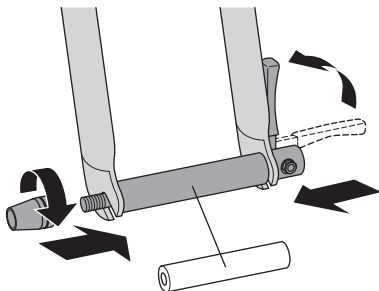

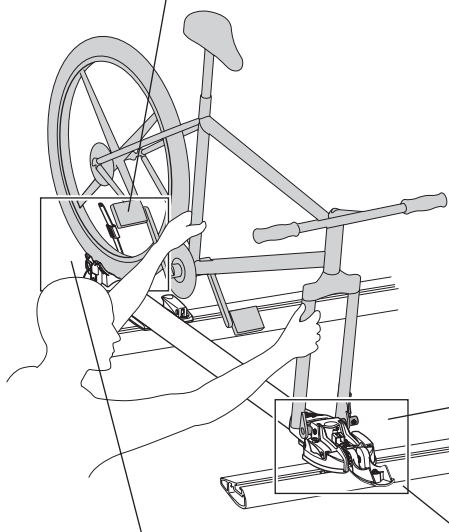
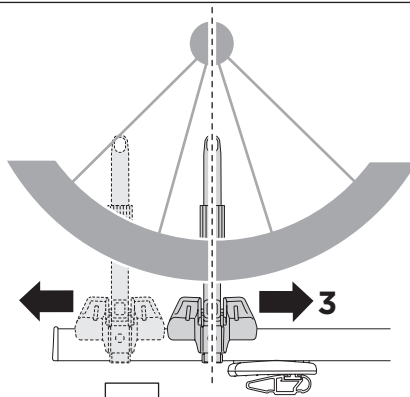
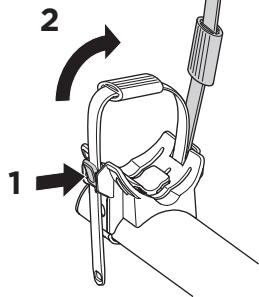
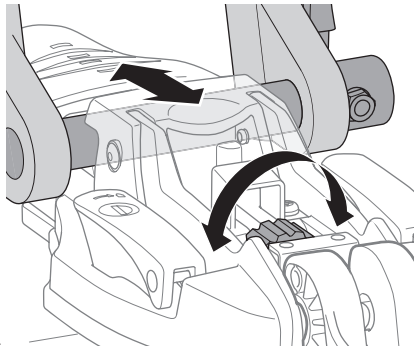
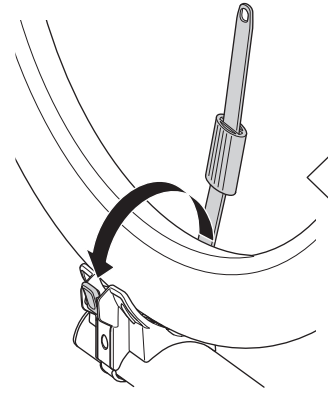
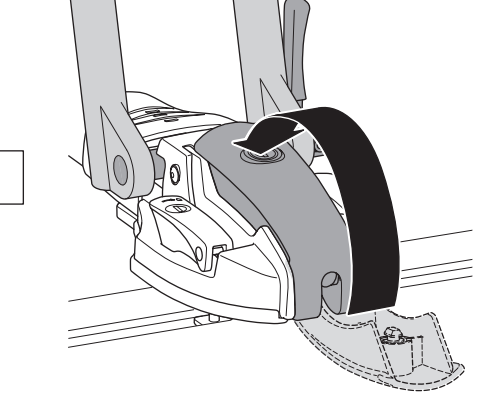
5**A****B****D****C**

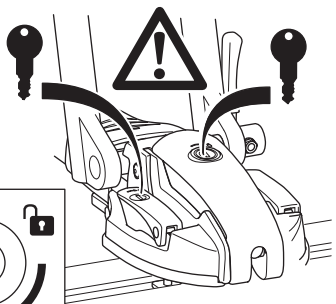
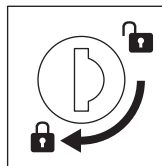
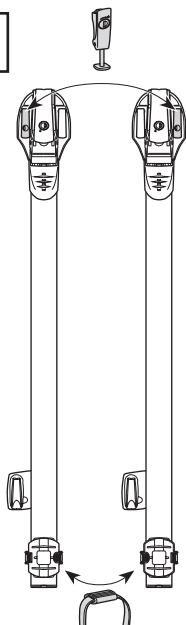
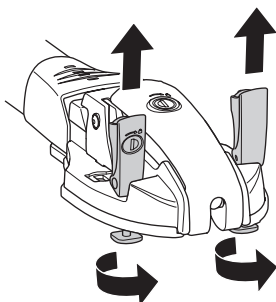
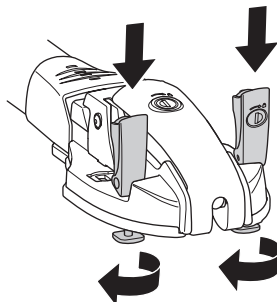
6**x1****i****EN** Left-hand fitting**DE** Montage links**FR** Montage côté gauche**NL** Montage aan de linker kant**IT** Montaggio a sinistra**ES** Montaje a izquierda**PT** Montagem do lado esquerdo**SV** Vänstermonterad**DK** Venstremontering**NO** Venstremontering**FI** Asennus vasemmalle**ET** Vasakpoolne kinnitamine**LV** Kreisais stiprinājums**LT** Kairysis pritvirtinimas**PL** Montaż z lewej**RU** Установка на левую сторону**UK** Установка на ліву сторону**BG** Монтаж отляво**CS** Montáž z levé strany**SK** Montáž na ľavej strane**SL** Pritrjevanje z leve strani**HR/BiH** Montaža sa lijeve strane**RO** Montare pe partea stângă**HU** Bal oldalról szerelhető**EL** Τοποθέτηση αριστερά**TR** Sol elle montaj**AR** التركيب في الجانب الأيسر**HE** התקנה מהצד השמאלי**ZH** 从左侧安装**JA** 左手装着**KO** 왼손 장착**TH** ตัวยึดด้านซ้ายมือ**A****B**

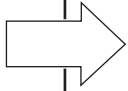

i

C

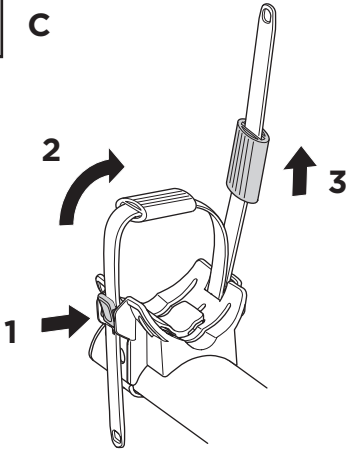

D

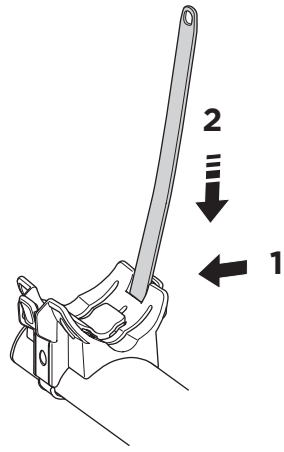

E

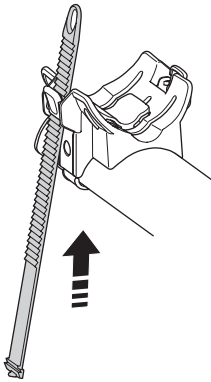

F

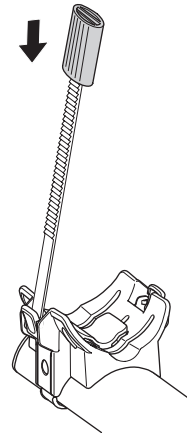

i

9 mm Quick Release:

12-20 mm Thru Axles:

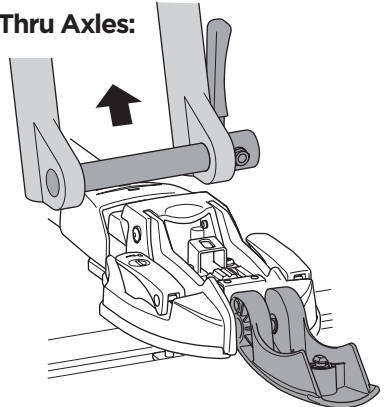
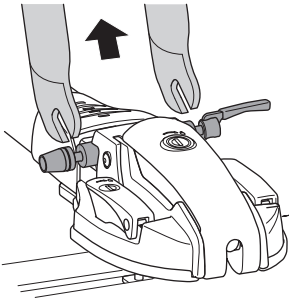

EN Accessories	DK Tilbehør	UK Аксессуары	EL Εξαρτήματα
DE Zubehör	NO Tilbehør	BG Принадлежности	TR Aksesuarlar
FR Accessoires	FI Lisävarusteet	CS Doplňky	الملاحقا AR
NL Accessoires	ET Lisavarustus	SK Príslušenstvo	אביזרים HE
IT Accessori	LV Piederumi	SL Dodatki	ZH 附件
ES Accesorios	LT Priedai	HR/BiH Dodaci	JA アクセサリー
PT Acessórios	PL Akcesoria	RO Accesorii	KO 액세서리
SV Tillbehör	RU Аксессуары	HU Tartozékok	TH อุปกรณ์เสริม

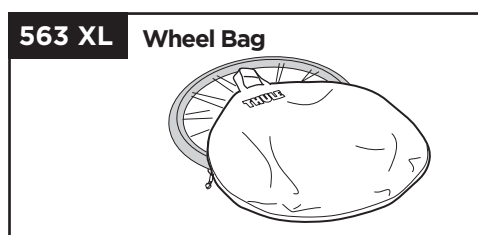
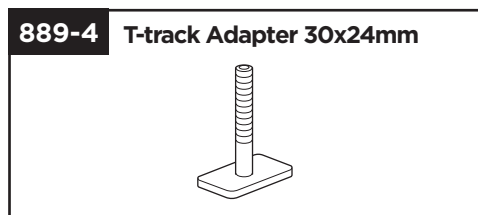
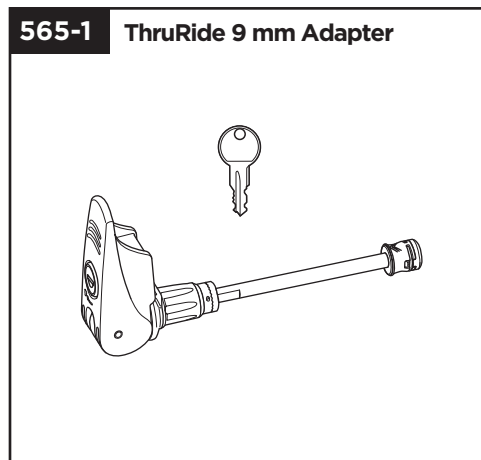

Thule One-Key System

544		(x4)
596		(x6)
588		(x8)
452		(x12)

