

Kit 1552

RENAULT Megane III, 5-dr Hatchback, 09–

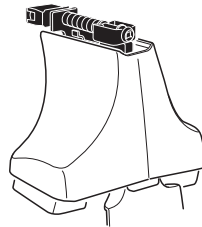

750

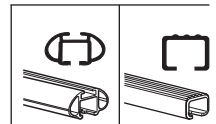

THULE[®]
SWEDEN

ISO 11154-E

xx kg
 xx lbs + 7 kg
 15,4 lbs = **Max. 65kg**
Max. 143 lbs

80 km/h 50 Mph
 130 km/h 80 Mph
 40 km/h 25 Mph
km/h Mph

THULE

Kit XXXX
 instructions

x1
 x4
 x4
 750

x2
 x2
 x2
 x2
 x4
 x4
 x1
 x2
 x2
 x4

926 x 4
196 x 2
251 x 1
252 x 1
x 1

Kit

1

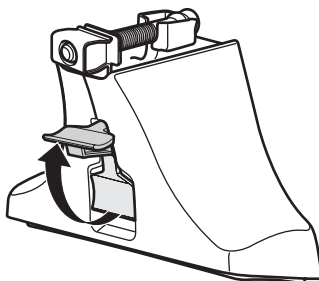

2



+

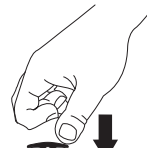
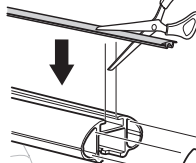
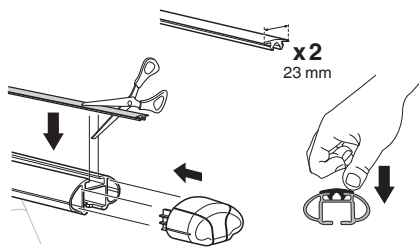
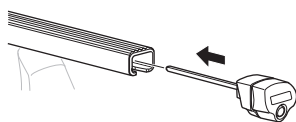
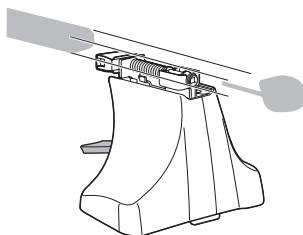

3

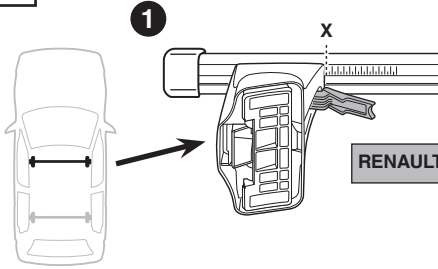

RENAULT Megane III, 5-dr Hatchback, 09-

X
36

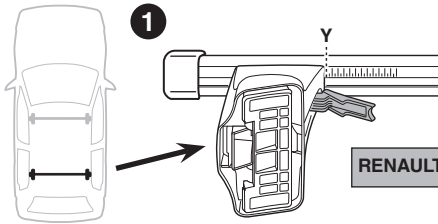
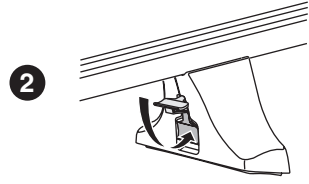

RENAULT Megane III, 5-dr Hatchback, 09-

Y
32,5

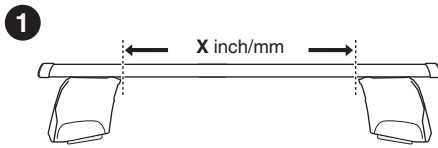
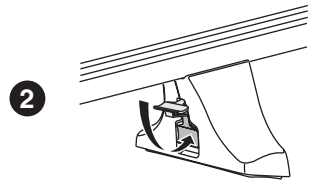

RENAULT Megane III, 5-dr Hatchback, 09-

X inch	X mm
39 3/4"	1011 mm

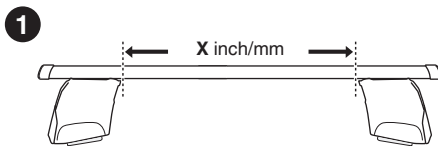
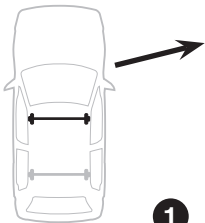
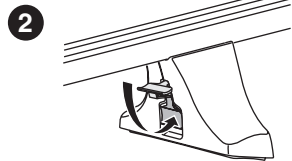

RENAULT Megane III, 5-dr Hatchback, 09-

Y inch	Y mm
38 3/8"	976 mm

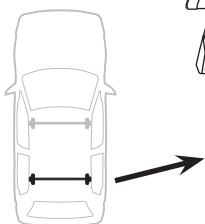
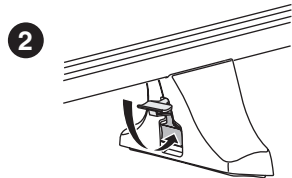

4

RENAULT Megane III, 5-dr Hatchback, 09-

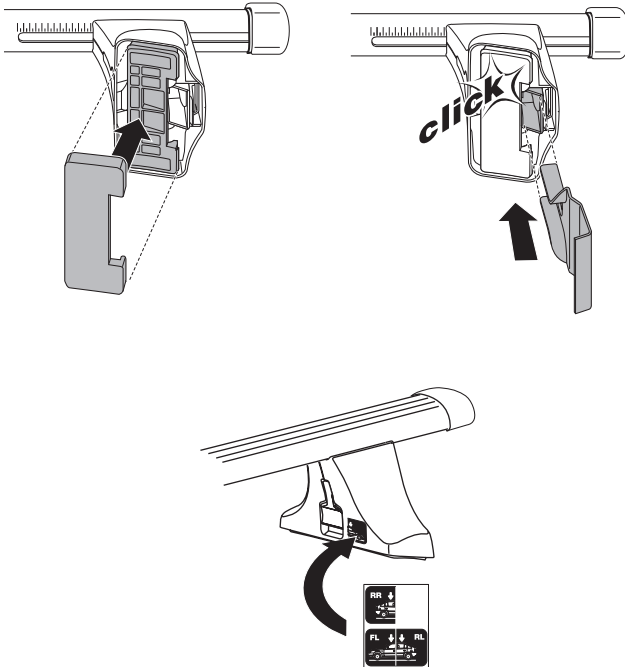
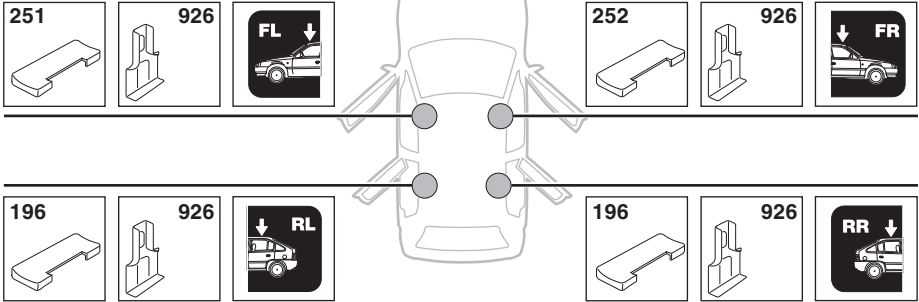

5

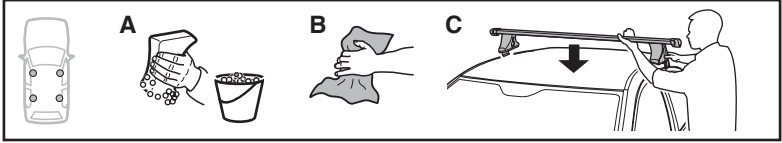

	X mm	Y mm	X inch	Y inch
RENAULT Megane III, 5-dr Hatchback, 09-	120 mm	760 mm	4 3/4"	29 7/8"

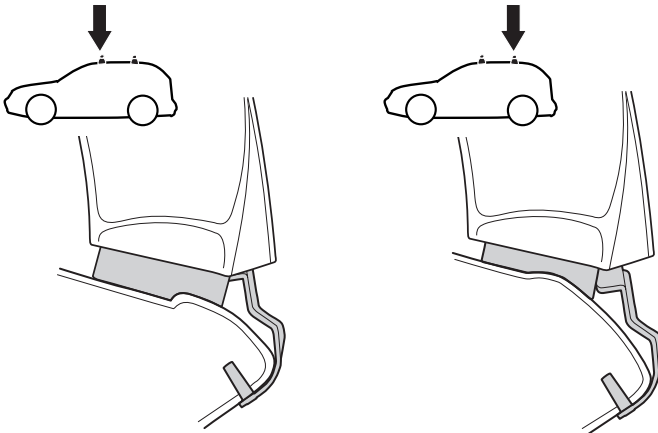
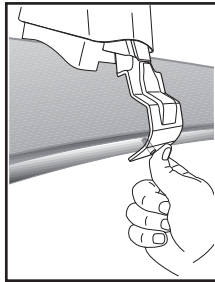
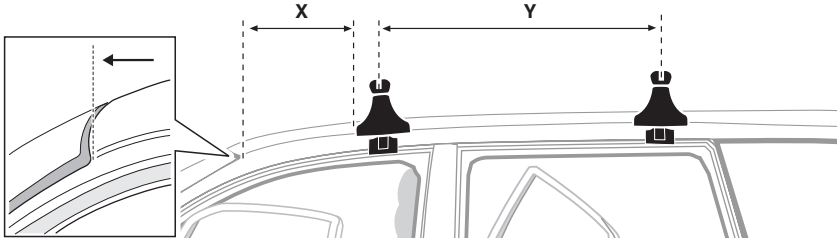

6

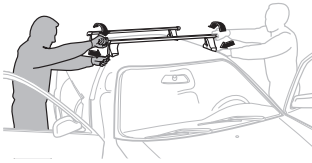

GB/US Tighten alternately
D Die Schrauben abwechselnd anziehen
F Serrer alternativement chaque côté
NL Afwisselend aan de linker- en de rechterkant aandraaien
I Alternare il serraggio delle viti
E Apretar alternativamente
PT Aperte alternadamente
S Dra åt växelvis
FIN Kierrä vuorotellen
EST Pinguldage vaheldumisi
LAT Pielvecliet pamišus
LIT Užsukinėkite pakaitomis
PL Śruby dokręcaj naprzemiennie
RU Затягивайте попеременно

CZ Pokręťta багаžníka dokręcaj naprzemiennie.
SK Dofahujte striedavo
SLO Privijajte izmenično.
HR Naizmjenično zategnite
HU Egymástól fűggetlenül szorítandó
GR Σφιγγετε εναλλάξ
TR Dönüşümlü sıkın

中文 交替拧紧

한국어 번갈아 가며 조이십시오.

日本語 交互に締め付けてください。

ไทย ชั้้นไขแบบสลับ

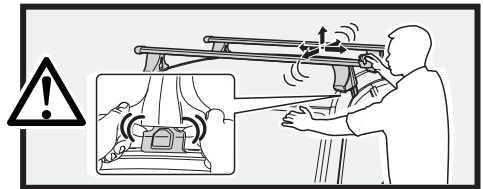
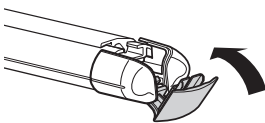
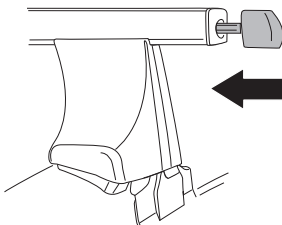
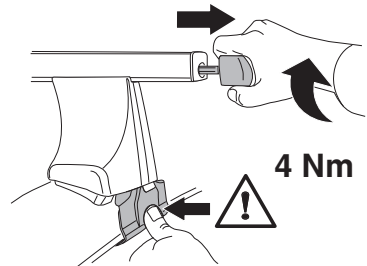
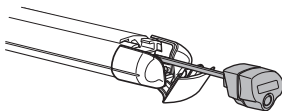
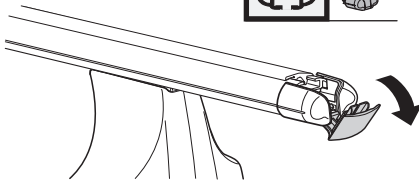

7

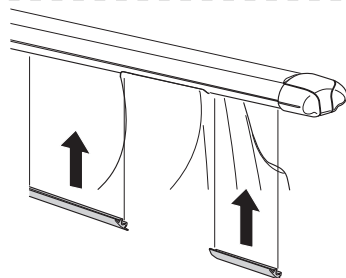
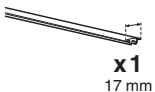

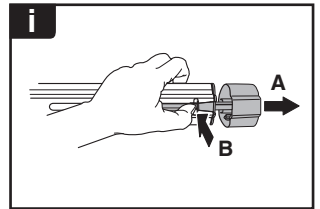
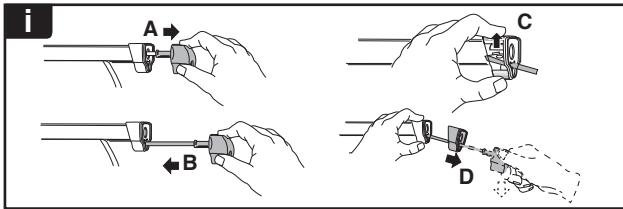
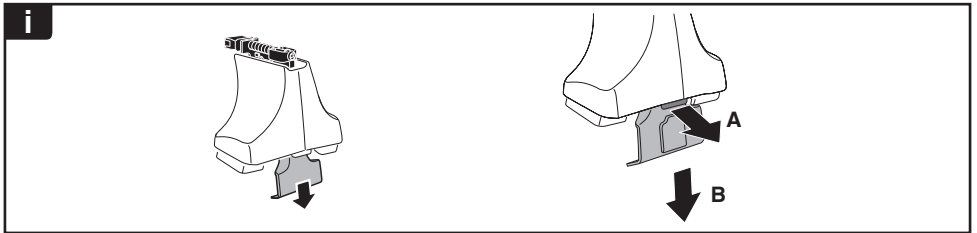
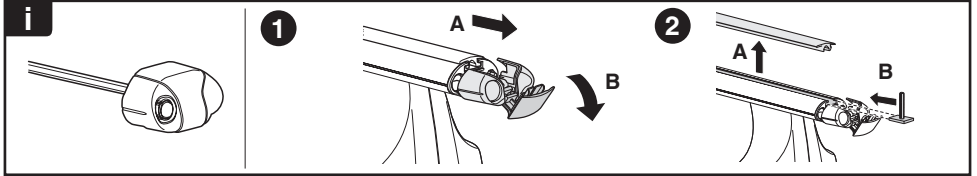
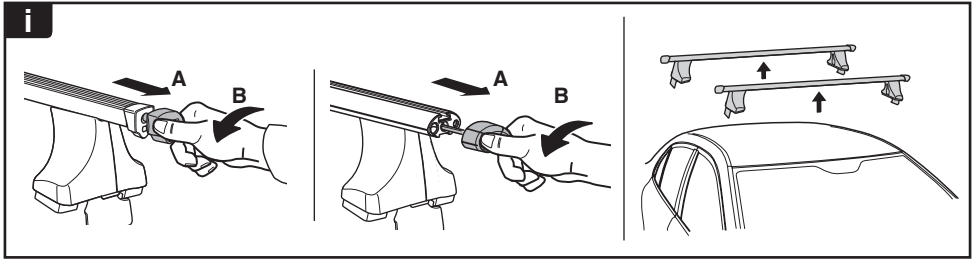

THULE
SWEDEN
**ONE
KEY
SYSTEM**

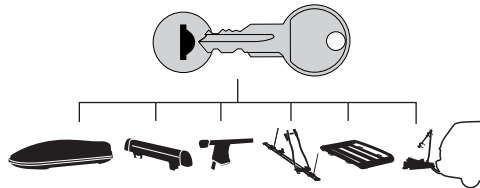

544		(x4)
596		(x6)
588		(x8)
NA 510		(x10)
EUR 452		(x12)
ASIA		

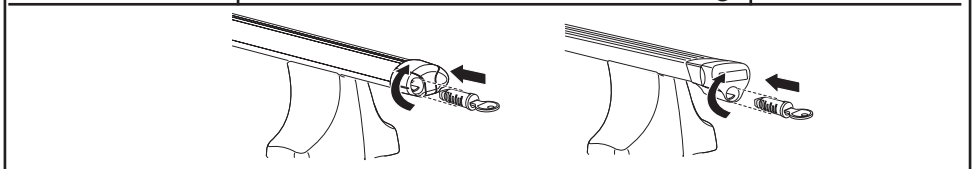

WW ▶ Thule Sweden AB, Box 69, 330 33 Hillerstorp, SWEDEN
NA ▶ Thule Inc., 42 Silvermine Road, Seymour, Connecticut 06483, USA

info@thule.com
customer.service@thule.com

www.thule.com

503-1552-02